

DH-PFA121

Water-proof Junction Box



Features

- Aesthetic design
- Material: aluminum
- IP66 junction box

Technical Specifications

Model	DH-PFA121
General	
Material	Aluminum
Dimension (WxHxD)	134.0mmx133.5mmx56.0mm (5.28"x5.25"x2.20")
Pipe Thread	G3/4"
Weight	0.54kg(1.19lb)
Load Bearing	3.0kg(6.61lb)
Color	White
Protection	IP66
Operating Temperature	-40°C~+60°C(-40°F~+140°F)
Humidity	0~90% RH
Applicable Model	Please see "Accessory Selection"

Order Information

Type	Part Number	Description
Camera Mount	DH-PFA121	Water-proof junction box
	PFA121	Water-proof junction box

Dimensions (mm/inch)

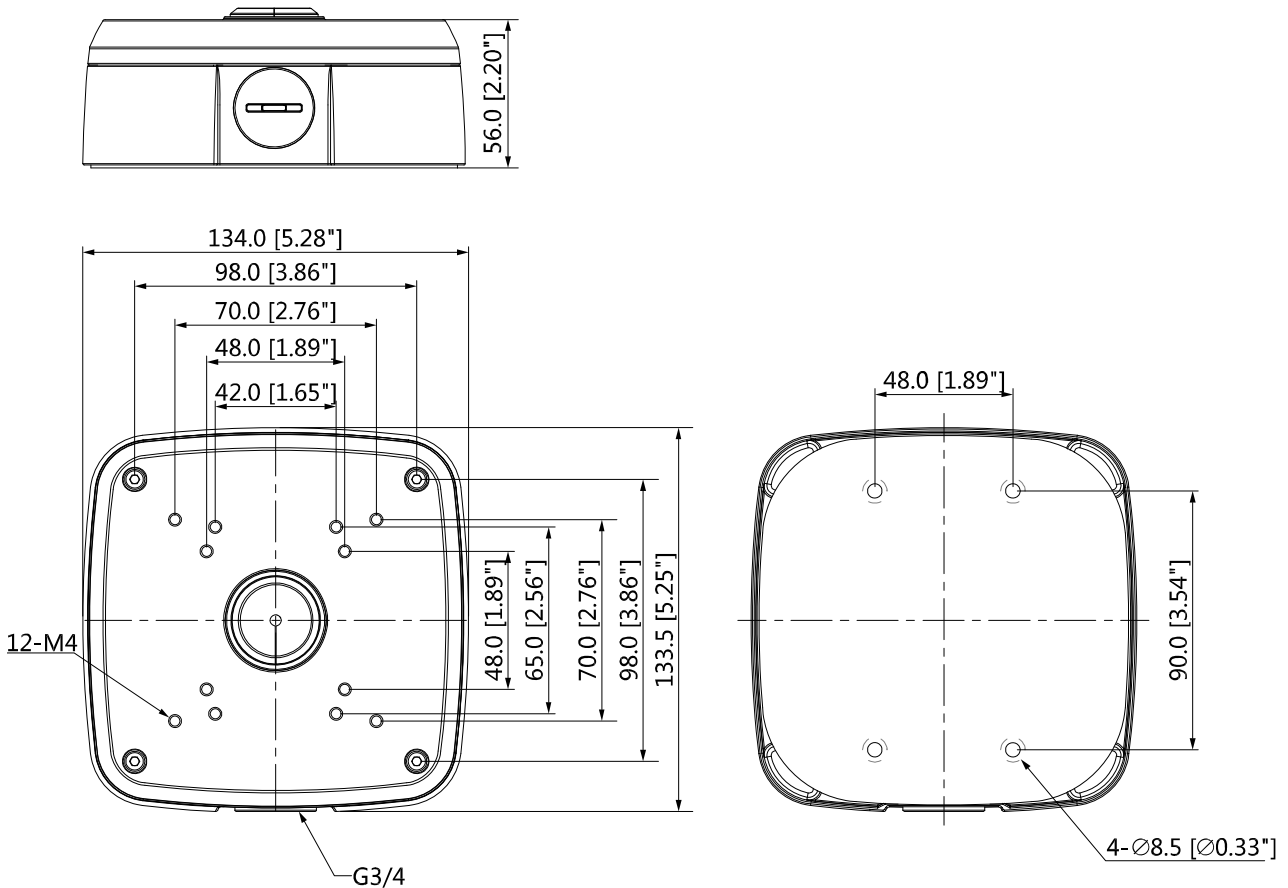

Application

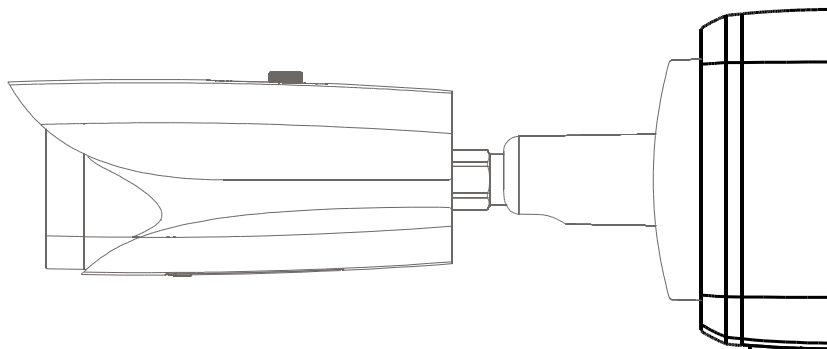

Package Information

- Water-proof junction box *1
- M4x10 screw *4
- ST6 screw *4
- Plastic anchor *4
- S3.0 wrench *1